

Status LEDs

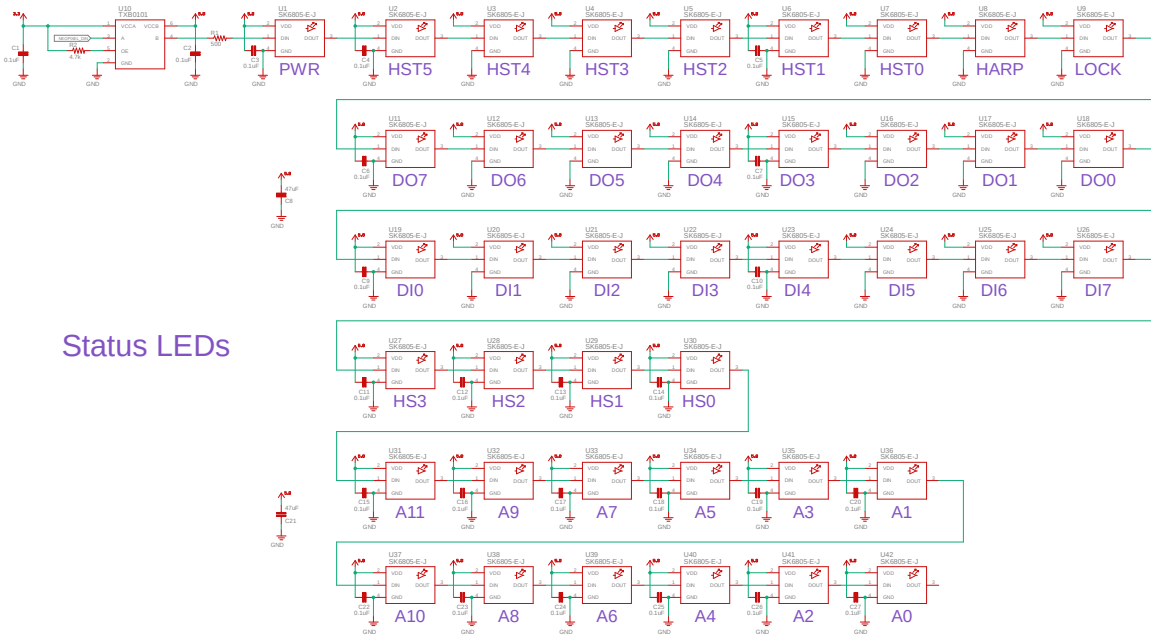

Headstage Ports

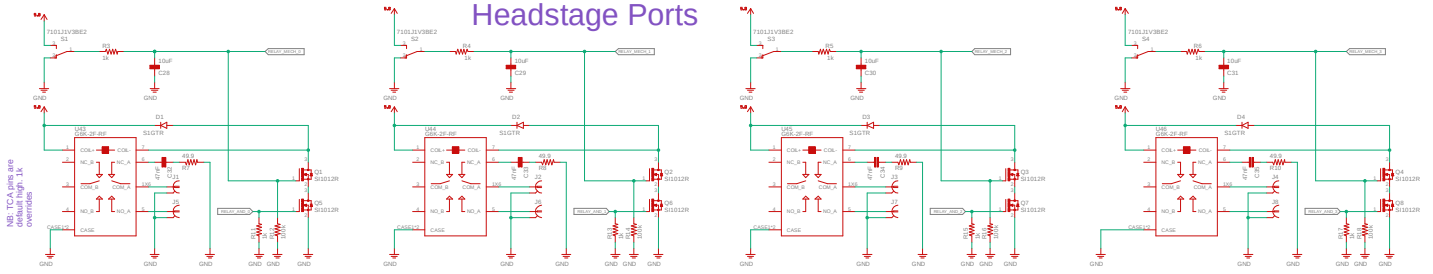

Power

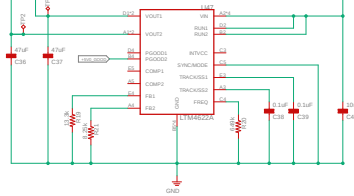

CLK Feedthrough

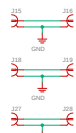

Analog IO

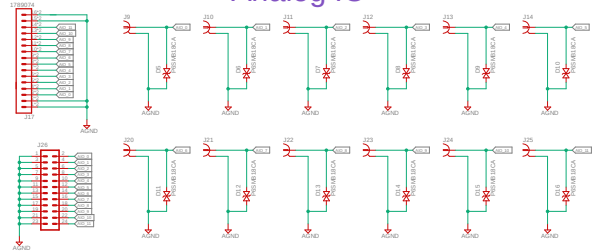

HARP Bus

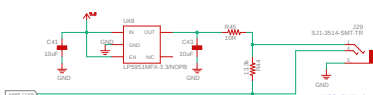

FPGA

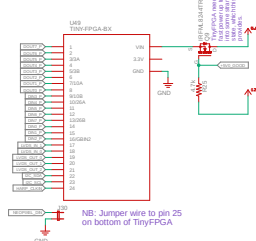

IO Expander

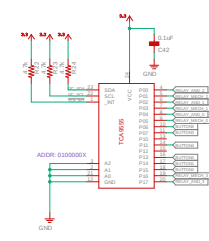

Host AUX

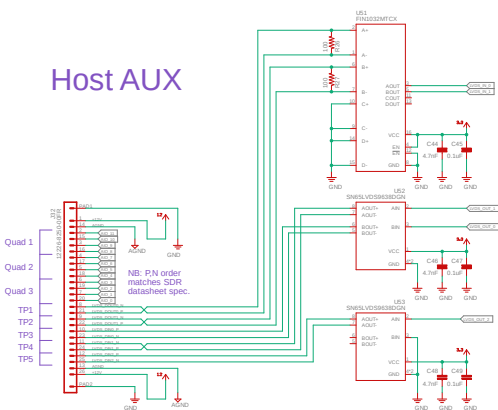

Buttons

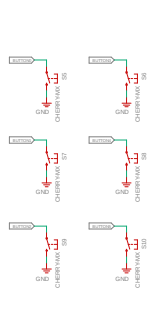

Digital IO

